

Data Sheet



Article number: 0125064

Description: Retaining ring SP47
Spring steel

Measures

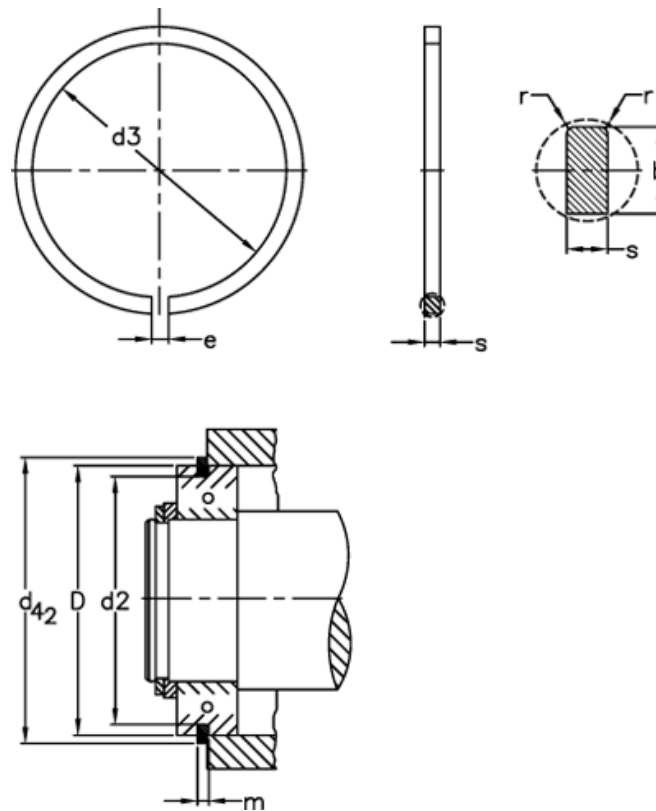

b	= 4.04	FRg kN	= 2.29	tol	= -0.15
D	= 47	FR kN	= 12.1	tol	= -0.1
d2	= 44.60	g	= 2.0	tol	= -0.25
d3	= 43.7	K kN-mm	= 22.4	tol	= 0.3
d42	= 52.7	m	= 1.35	tol	= 0.5
Description	= SP 47	n abl x 1000	= 7.0	Weight kg/1000	= 5.3
e	= 4	r min	= 0.4		
FN kN	= 28.8	s	= 1.12		